



Lentek has your Solution...The PORTABLE, WIRELESS,

LENTEK LIMITED WARRANTY

Purchase Date _____ Item #(Above UPC code) _____

This Limited Warranty is effective upon purchase. Please complete the attached Registration and return to Lentek International.

1. Lentek International warrants this product to be free of manufacturing defects. Should any such defect develop or become evident within ONE year from the date of purchase, Lentek International will replace the entire product or, at its option, repair or replace the defective part(s) without charge.
2. Securely pack the entire unit. Be sure carton clearly identifies sender by name and address. Attach a letter or card describing the defect. Original receipt of purchase must be included in returned package for warranty coverage.
3. This warranty is void if damage or malfunction is due to abuse or failure to operate product in accordance with instructions and on recommended electrical current.

Mail prepaid via insured parcel post to:

LENTEK INTERNATIONAL • WARRANTY DEPARTMENT
3600 Commerce Blvd. • DOCK #7 • KISSIMMEE, FL 34741



LENTEK INTERNATIONAL INC.
3700 Commerce Blvd.
Kissimmee, FL 34741

Phone: 407•857•8786
Fax: 407•857•4045
Toll Free: 888•3LENTEK
Email: customerservice@lentek.com



SUPER BARK FREE®

Directions For Use

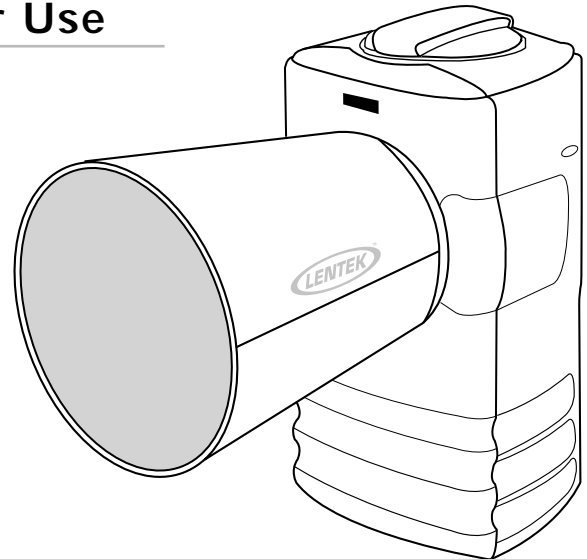

Dear Customer,

Thank you and congratulations on your purchase of this ingenious device. This product is the latest in new technology from Lentek™. We back our product with a one (1) year limited warranty. Your satisfaction is very important to us.

Visit our website at: www.lentek.com and view the rest of our products, such as our Wine Collection, ThermaFridges, Pet Appliance™, and Pest Control devices. While you're there, register your new purchase, sign up to receive our newsletter, and learn more about our company.

Questions can also be asked on our website, or you can call: 1-888-3LENTEK, or 407-582-9320 or contact your local Lentek dealer.

We look forward to serving you, now and in the future.

Enjoy!

Lou

Lou Lentine
President/CEO



What Results to Expect:

Properly setting the "Sensitivity" and "Bark Number" switches to activate the unit only when your dog barks will help to maintain the "Novel Stimulus" aspect of the Super Bark Free. Dogs learn to associate the loud, irritating sound produced by the unit as being a result of barking and stop barking to stop the Super Bark Free sound. Always remember, the activation microphone in the Super Bark Free just detects sound, it can not tell the difference between different types of sounds.

Do not try to instigate barking from your dog to see if the Super Bark Free is working. A dog will always bark if harassed.

Most dogs find that being close to an activated Super Bark Free is very distressing and uncomfortable. Sometimes older dogs or breeds with congenital hearing problems are unable to hear the ultrasonic sounds emitted and ignore the Super Bark Free. This is also true of situations where there is a lot of other noise close to the dogs. The ultrasonic sound emitted is drowned out by the other noise.

There are no 100% perfect cures that stop 100% of the barking, this includes the Super Bark Free. Within a few days, if you haven't noticed a significant reduction in the overall amount of barking, especially at night, then you have a more serious problem than just simple unnecessary nuisance and boredom barking. Some of the more severe problems include:

Protective Barking- They may bark at trespassers or neighbors that tease or threaten them.

Dogs Trained to Bark- They may inadvertently be trained to bark, by receiving attention (both positive and negative) for barking.

Feeding Time and Work Time Barking- We recommend that you disconnect Bark Free when feeding. When walking one dog and leaving others behind, get out of sight as soon as possible.

Hearing Problems- Deaf dogs will not react to the Super Bark Free. Dogs with high frequency hearing damage may react to the audible setting. However you and your neighbors may hear it.

High Stress Environments- Bark Free is not recommended for boarding kennels, animal shelters and grooming salons. These locations generate protective and fear barking.

PARTS LIST

Batteries:

The Super Bark Free uses four (4) "D" size alkaline batteries or the power adapter supplied. Batteries last approximately 2000 sound releases under normal conditions.

To Install Batteries

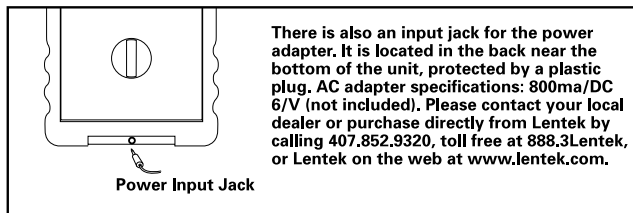
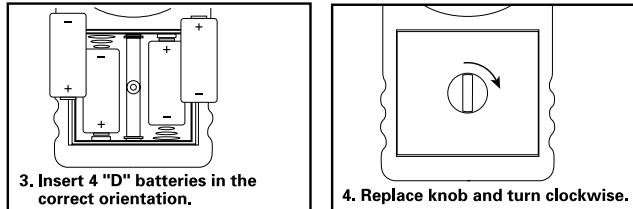
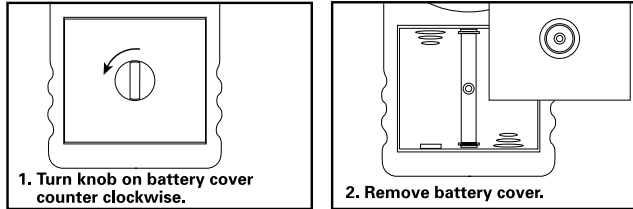

Super Bark Free

- A- Super Bark Free Unit
- B- Sound Focusing Cone Halves
- C- Super Bark Free Control Cover
- D- Mounting Bracket Attaching to Unit
- E- Mounting Bracket Attaching to Wall or Post
- F- Power Supply (UL Listed). 120V AC Input
With 6V DC, 800 mA Output

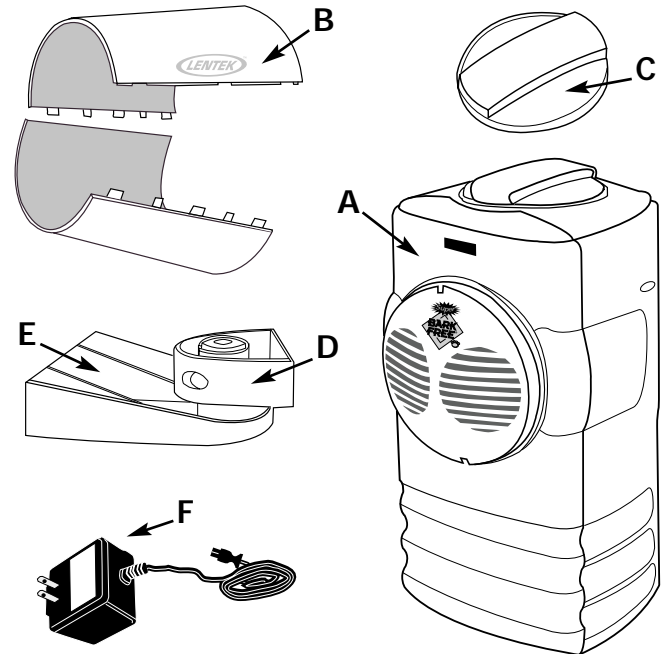

GENERAL SAFETY INFORMATION

This manual contains important information about the operation and maintenance of the Lentek Super Bark Free. General safety information is presented here and is also located throughout this manual. Keep this manual for future reference and to educate any new users. The symbols shown below are used throughout this manual for your safety and should always be heeded.

DANGER

DANGER indicates an immediately hazardous situation which, if not avoided, will result in death or serious injury.

WARNING

WARNING indicates a potentially hazardous situation which, if not avoided, could result in death or serious injury.

CAUTION

CAUTION indicates a potentially hazardous situation which, if not avoided, may result in minor or moderate personal injury or property damage.

Activation Microphone and LEDs:

The activation microphone is located on the face of the Super Bark Free above the speaker housing.

See Illustration. The activation microphone is between the LED's and should be kept free of obstruction or dirt. The activation microphone in the Super Bark Free just detects sound, it can not tell the difference between different types of sounds.

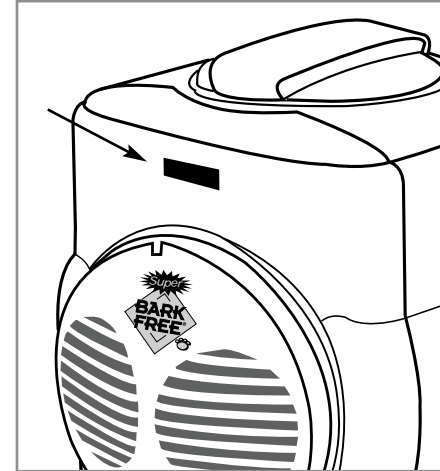

The left LED is red and lights to indicate that the unit has power. The right LED is green and lights when the unit is set to ultrasonic sound output.

Control Cover:

There is a control cover located on the top of the unit. It can be removed by giving it 1/8th of a turn clockwise, then lifting the cover off.

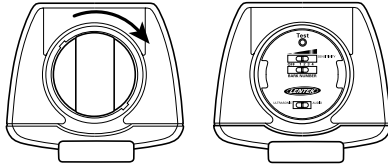

Control Panel:

Test Button: The user can press this button to hear that the unit is working.

Sensitivity Switch: Slide to the right to increase the microphone activation sensitivity. Slide to the left to decrease the microphone activation sensitivity. This allows you to adjust how loud barking must be to activate the unit. Use the "Audio" setting on the sound output so that you can hear activation when adjusting the sensitivity to ensure a good response.

Bark Number Switch: Use to select how many barks are required in a ten second time period before the unit will activate.

Ultrasonic / Audio Switch: Use to select ultrasonic (dog can hear, but you can't) or audio (everyone can hear) sound output when unit is activated.

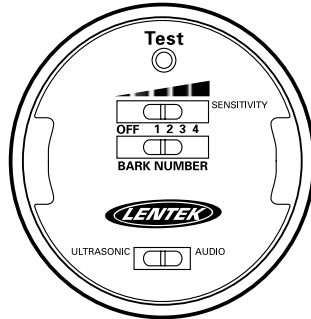

1. **!CAUTION:** The Super Bark Free is for **OUTDOOR USE ONLY**. Optional power supply must be kept dry.
2. **!CAUTION:** do not place your ears close to the unit speakers or use in confined spaces as hearing damage may result.
3. **!CAUTION:** Not for use by children.
4. When using the optional power supply, use only extension cords having plugs and receptacles that accept the Super Bark Free plug.
5. Use only extension cords that are UL approved. Replace or repair damaged extension cords.
6. Don't abuse the power supply cord. Never yank it to disconnect from receptacle or from the Super Bark Free. Keep all electrical cords away from heat, oil, and sharp edges.
7. **!WARNING:** The connection between the Super Bark Free and any extension cord used must be kept dry and off of the ground.
8. Do not insert foreign objects into this or any electrical product.
9. **!WARNING:** Do not immerse this unit in water or other liquid. Unplug before cleaning.
10. Do not use harsh solvents on any part of this product.
11. All repairs to the Super Bark Free must be performed only by qualified service personnel.
12. Read and follow all instructions prior to use of the Super Bark Free.

DIRECTIONS FOR USE

The Sound Focusing Cone:

The two halves of the Sound Focusing Cone snap together to form a cone that attaches to the face of the Super Bark Free unit. **See Illustration A.** Be sure to completely press the halves together. The cone can be used to focus and direct the sound output of the Super Bark Free toward a specific target area, such as your dog's kennel.

To attach the cone to the Super Bark Free's face, line up the pins in the smaller cone end with the notches located at the 12 and 6 o'clock positions on the speaker housing.

See Illustration B. Slide the pins into the notches and turn clockwise until secure (about 1/4 inch).

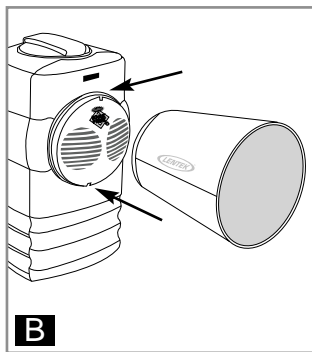
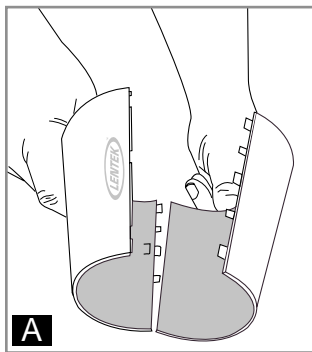

Mounting:

The Super Bark Free is provided with mounting brackets that attach to an outside wall or post to securely hold the unit in position for use. The Super Bark Free should be placed as close to the source of problem barking as possible, facing the dog(s), and at a height no greater than 6 feet. Be sure that your dog(s) can not reach the unit or the power supply cord to chew on them.

Wall Mount

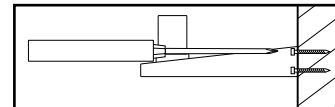
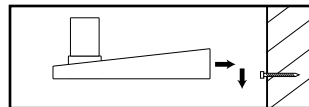

Fix the bracket to the wall or any vertical surface by using 3 long screws. Fasten the middle screw FIRST.

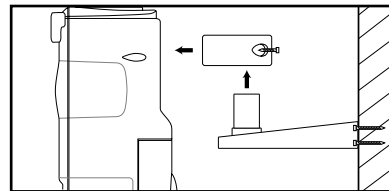

Use 2 short screws to attach the unit connector to the unit. Then put the unit onto the bracket. Turn the unit in the direction you want it to face.

Post Mount

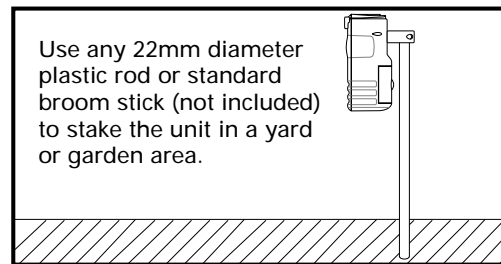

Use any 22mm diameter plastic rod or standard broom stick (not included) to stake the unit in a yard or garden area.

The placement of the Bark Free is important because ultrasonic sound patterns do not penetrate solid materials. The ultrasonic sound is deflected or absorbed within the environment. Hard surfaces such as concrete, wood, metal, plastic, and window glass will deflect the sound. Soft surfaces such as grass, plants, or bedding can absorb the sound. The unit should be placed with no obstructions between the Super Bark Free and the dog(s). Think "open line of sight".